

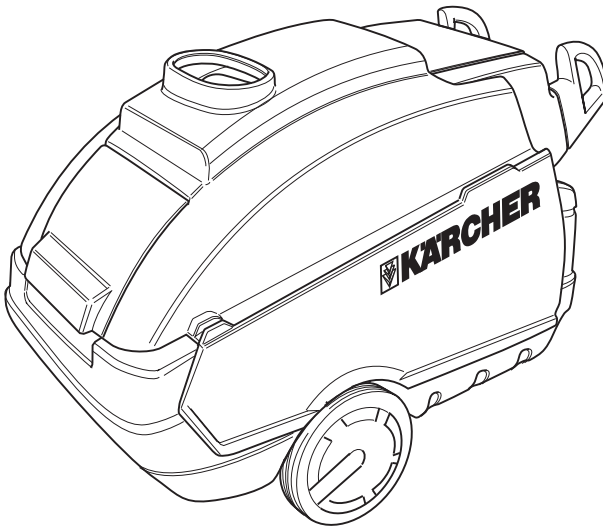

KÄRCHER

DR

HDS Super
HDS 695 S
HDS 745
HDS 895 S
HDS 995
HDS 1195
HDS 1295



1

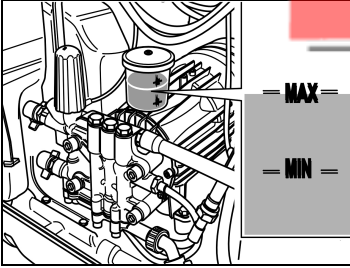

5

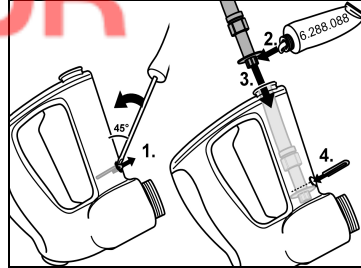

2

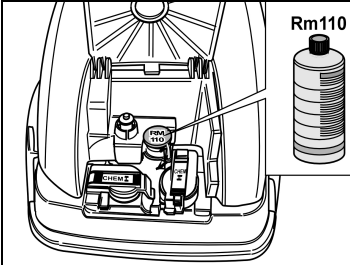

6

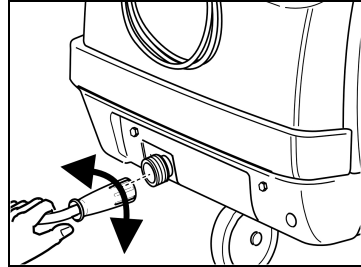

3

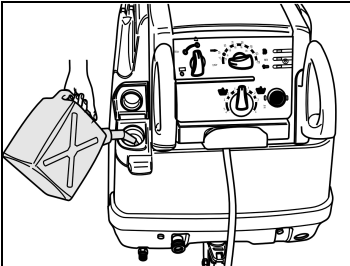

7

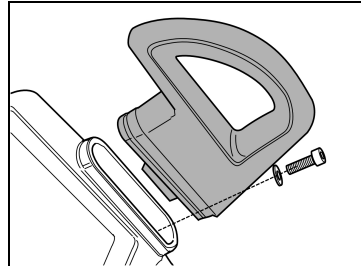

4

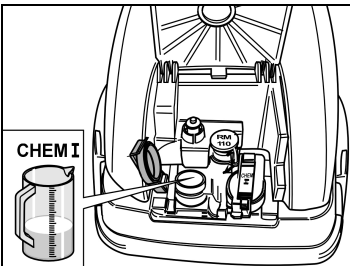

8

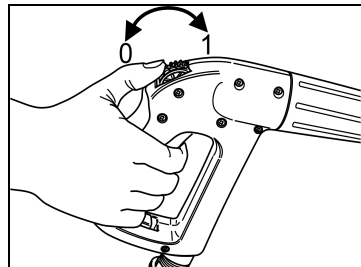

9

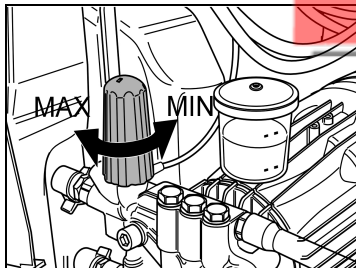

13

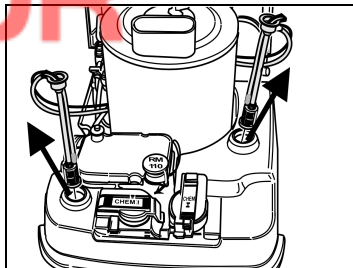

10

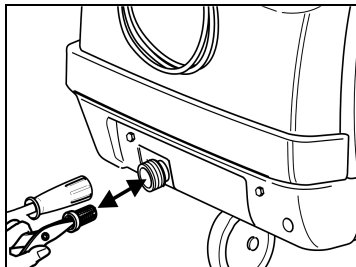

14

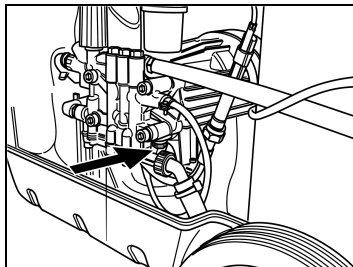

11

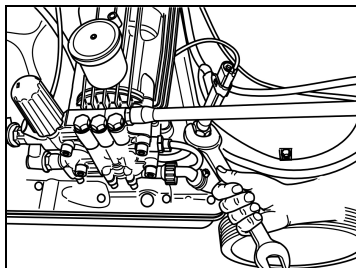

15

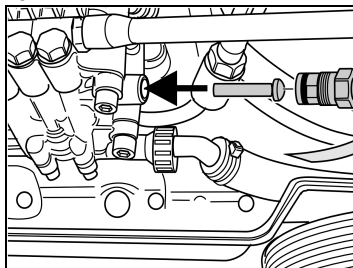

12

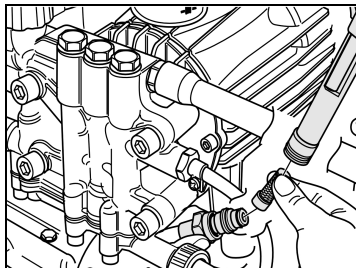

16

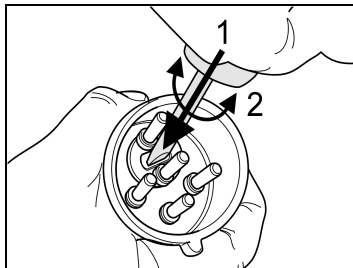

CONTENTS

Environmental protection	4	Faults	11
Illustration of the unit	5	Warranty	13
Operating controls	5	General information	13
Note on the operating instructions	6	Technical data	14
Commissioning	6	Spare Parts List	16
Check the oil level	6		
Filling with scale inhibitor	6		
Filling with fuel	6		
Filling with cleaning agent	6		
Mounting handgun	6		
Mounting handle	6		
Water connection	6		
Drawing in water from tank	7		
Mains connection	7		
Operation	7		
Switching the unit on	7		
Setting cleaning temperature	7		
Setting operating pressure and flow rate	7		
Measuring out the cleaning agent	8		
Intended use	8		
Cleaning	8		
Operation with cold water	8		
Operation with hot water	8		
Operation with steam	8		
Safety shut-off	9		
Each time after usage	9		
Reading the operating hours	9		
Shut-down	9		
Maintenance	9		
Maintenance intervals	9		
Maintenance tasks	10		
Indicator lamp (item 28) motor/electronics module is lit	10		
Cleaning strainer in water connection	10		
Cleaning strainer in low water connection	10		
Cleaning filter at cleaning-agent suction hose	10		
Changing oil	10		



Prior to initial operation it is mandatory to read the operating instructions and the notes on safety no. 5.951-949!

Inform retailer immediately of any transportation damage.

ENVIRONMENTAL PROTECTION

Items used when working, such as fuel, oil, cleaning agent and contaminated maintenance materials, are to be deposited at a special collection point.



Packaging materials, metal and plastic containers are to be set aside for recycling as appropriate.

Disposal of used units

Your Kärcher retailer will provide you with information on disposal means harmless to the environment.

ILLUSTRATION OF THE UNIT

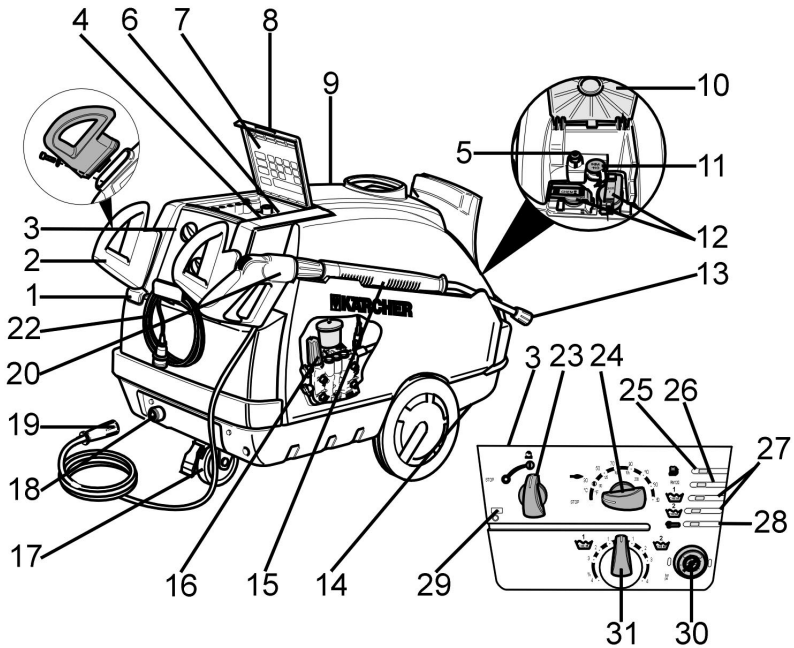

CONTROL ELEMENTS

- | | |
|---|--|
| 1 Fuel tank inlet | 23 Unit switch |
| 2 Handle | 24 Temperature regulator |
| 3 Instrument panel | 25 Fuel indicator lamp |
| 4 Window with the maintenance/fault display
(only HDS 995, HDS 1295) | 26 Scale inhibitor indicator lamp |
| 5 Cover latch | 27 Indicator lamp-CHEM 1 , CHEM 2
(only HDS 1295) |
| 6 Compartment für accessories | 28 Indicator lamp-engine
(all machines, except HDS Super) |
| 7 Short operating instructions | 29 Ready to working indicator lamp |
| 8 Cover for compartment | 30 Pressure gauge |
| 9 Unit cover | 31 Metering valve for cleaning agent |
| 10 Cover for tank inlet | |
| 11 Tank inlet für scale inhibitor | |
| 12 tank inlet for cleaning agent | |
| 13 High-pressure nozzle | |
| 14 Handle grips in the chassis | |
| 15 Steel pipe | |
| 16 Pressure and flow control | |
| 17 Swivel caster with parking brake | |
| 18 Water inlet with strainer (coarse) | |
| 19 High-pressure connection | |
| 20 Handgun with high-pressure hose | |
| 22 Electric power cord | |

NOTE ON THE OPERATING INSTRUCTIONS

All of the item numbers described below in the operating instructions are referenced in the illustration of the unit.

COMMISSIONING

- Unit, piping, high-pressure hose and connections must be in perfect working order!
- Lock the hand brake.

Checking oil level**Figure 1****Contact Kärcher AFTER-SALES SERVICE immediately if oil is opaque!**

If oil level is approaching MIN mark, fill up with oil as far as MAX mark.

Seal oil filler inlet.

Refer to technical data for oil grade.

Filling with scale inhibitor**Figure 2**

(sample pack included with scope of delivery)

Scale inhibitor stops heating coil becoming calcified when using hard tap water. Is metered in at the inlet in the water reservoir one drop at a time.

The metering is set at the factory to medium-hard water.

For other water hardness classes, call in Kärcher AFTER-SALES SERVICE to perform adjustment to local conditions.

Filling with fuel

- Never operate unit with fuel tank empty! Fuel pump would otherwise be destroyed!

**Figure 3**

Only fill with diesel fuel or light fuel oil. It is forbidden to use unsuitable fuels, e.g. benzene (explosion hazard, damage to unit).

Close tank cap

Wipe off excess fuel

Filling with cleaning agent

- * Only use Kärcher products.
- * Never pour in solvent (petrol, acetone, thinner etc.)!
- * Avoid contact with eyes and skin
- * Pay attention to cleaning-agent manufacturer's instructions on safety and handling

Kärcher can provide an individual range of cleaning and treatment agents.

Your dealer will be pleased to advise you.

Figure 4

Fill with cleaning agent

Mounting handgun

- Connect steel pipe (item 15) with handgun (item 20)
- Insert high-pressure nozzle in union nut
- Mount and tighten unit nut
- Mount the high-pressure hose to the high-pressure connection.(Figure 6)

Mounting of spare high-pressure hose**Figure 5****Mounting handle****Figure 7****Water connection**

For connected loads, refer to Technical Data. Install the supply hose to the water inlet (item 18) of the unit.

(supply hose is not part of scope of delivery)

Drawing in water from tank

When you suction water out of an open container you should

- disconnect the water inlet at the pump head.
- unscrew the top supply hose to the water tank and connect it to the pump head.
- use a water suction hose with a minimum diameter of 3/4" provided with a vacuum filter.

- * Until the pump sucks up water you should:
- turn the pressure and flow regulation to MAX.
 - close the metering valve for the cleaning agent.



- Never suction up water out of a potable water tank.
- Never suction up solvent-bearing liquids such as paint thinner, benzine, oil or unfiltered water. The seals in the unit are not resistant to solvents. The mist of solvents is highly inflammable, explosive and poisonous!

Mains connection

Refer to technical data and rating plate for connected loads.



Whenever socket is changed, check direction of rotation of motor

If direction of rotation is correct, powerful jet of air will be felt at exhaust-gas opening of burner. If the direction of rotation is wrong: Change the poles at the unit plug. See figure 16.

If an extension cable is used, this should always be fully uncoiled and have an adequate cross-section.

OPERATION

Switch the unit on

Set the unit switch (item 23) to "I"
The ready for working indicator lamp (item 29) is lit



The temperature regulator (item 24) must be at setting "0", since it is otherwise possible that the burner switches itself on

Unit starts up briefly and is switched off as soon as operating pressure is reached.

- * Turn the unit off immediately if during its operation the indicator lamps (item 25-item 28) light up. Eliminate fault, refer to Faults.

Figure 8

Release handgun

Actuation of handgun switches unit back on again.

Bleed pump if no water emerges from high-pressure nozzle. Refer to Faults "No build-up of pressure by unit"

Setting cleaning temperature

Set the temperature regulator (item 24) to the required temperature

30°C to 90°C
Hot water cleaning

100°C to 150°C
Clean with steam, with steam nozzle -
4.766-023, at HDS 1195 and HDS 1295 -
4.766-024

Setting operating pressure and flow rate

Figure 9

Turning regulator clockwise: Increases operating pressure (MAX)

Turning counter-clockwise: Reduces operating pressure (MIN)

Servopress control

Set the temperature regulator (item 24) to max. 98°C.

Set regulator to maximum operating pressure.

Figure 8

Operating pressure and flow rate can be set at handgun.

Set pressure on unit if use is to be made of reduced pressure for a lengthy period.

See figure 9

Measuring out the cleaning agent

- * Use cleaning agents sparingly to protect the environment
- * The cleaning agent must be suitable for the surface to be cleaned.

Set the concentration of the cleaning agent according to the manufacturer's recommendations at the cleaning agent metering valve (item 31)

Approximate values at maximum operating pressure

Intended use

Cleaning of: Machines, vehicles, buildings, tools, facades, terraces, garden tools, etc..



- * Engine cleaning is only to be performed in areas provided with oil separator.
- * Heed appropriate safety regulations for use at petrol stations or in other hazardous environments.

Working with high-pressure nozzle

Spray angle is crucial to efficiency of high-pressure jet.

Use is normally made of 25°fan jet nozzle (included).

Recommended nozzles, available as accessories

- For stubborn dirt 0°full jet nozzle
- For delicate surfaces and slight contamination 40°fan jet nozzle
- For thick layers of stubborn dirt dirt blaster
- Nozzle with variable spray angle, for adaptation to various cleaning tasks variable-angle nozzle

Cleaning

- * Set pressure/temperature and cleaning-agent concentration in line with surface to be cleaned
- * Always start by directing high-pressure jet from a good distance at object to be cleaned to avoid damage caused by excessive pressure.

Recommended cleaning method

Loosen up dirt:

Spray on cleaning agent sparingly and allow to react for 1...5 min (do not allow to dry on).

Remove dirt:

Spray off loosened-up dirt with high-pressure jet.

Operation with cold water

Removal of slight contamination and rinsing e.g.: Garden implements, terrace, tools, etc.

Set operating pressure as required

Set the temperature regulator (item 24) to "0"

Operation with hot water

- * Danger of scalding

Set the temperature regulator (item 24) to the required temperature

We recommend the following cleaning temperatures

- Slight contamination 30-50°C
- Protein soiling, e.g. in foodstuffs industry max. 60°C
- Motor vehicle cleaning, machine cleaning 60-90°C

Operation with steam



At operating temperatures above 98°C operating pressure must not exceed 32 bar.

Therefore the standard high-pressure nozzle must be replaced by the steam nozzle (manufacture no.: 4.766-023, for HDS 1195 and HDS 1295 4.766-024.0; see accessories).

- Set operating pressure to minimum value. See figure 9
- Set the temperature regulator (item 24) to min. 100°C

- * Danger of scalding!

We recommend the following cleaning temperatures

- Preservative removal, extremely greasy dirt 100-110°C
- Thawing of aggregates, certain facade cleaning operations up to 140°C

Safety shut-off

The pump automatically shuts down for safety reasons if the handgun is neither opened or closed for more than 30 minutes.

- To switch it on again turn the main switch to "0" and then back to the "I" position.

(The EPROM without disabling 6.682-595.0 is available from service)

EACH TIME AFTER USAGE**Following operation with cleaning agent**

- Set the cleaning agent metering valve (item 31) to "0"
- Set the unit switch (item 23) to "I"
- Actuate handgun and flush unit for approx. 1 min

Stopping machine

- Set the unit switch (item 23) to "0"
 - Shut off water supply
 - Switch the pump briefly on with the unit switch (item 23) (approx. 5 sec.)
 - Remove mains plug from socket ONLY with dry hands
 - Detach water connection
 - Actuate handgun to depressurise unit
-
- Lock the hand spray gun Figure 8
 - Engage spray lance in cover holder
 - Reel up the high-pressure hose and electric cables and attach them to fastenings

- * Take care not to kink high-pressure hose and cable!



Frost will destroy unit if water is not drained off completely!

Store unit in a frost-free location

Take unit out of service if frost-free storage is not possible.

READING THE OPERATING HOURS

(ONLY HDS 995 AND HDS 1295)

When you open the storage compartment cover flap, you will notice the electronic operating hours display in the viewing window, e.g.

h	2	4	5
---	---	---	---

= 245 hours.

DISCONTINUATION OF USAGE

In the event of lengthy periods of non-use or if frost-free storage is not possible:

- Drain off water and flush out equipment with antifreeze
- Drain cleaning fluid tank

Drain off water

- Unscrew water supply hose and high-pressure hose
- Unscrew supply line at boiler base and allow heating coil to drain
- Run unit for max. 1 min until pump and lines are empty

Flushing unit with anti-freeze

- Fill the float tank with a commercially available antifreezing compound
- Switch the unit on (without the burner) until it is thoroughly purged
- Observe handling instructions of antifreeze manufacturer
- By this means, a certain degree of corrosion protection is achieved

MAINTENANCE

- * Disconnect unit from mains before carrying out any maintenance or repair work.
- * Always use genuine spare parts

Shut off unit before performing any work, refer to AFTER USE.

Set the unit switch (item 23) to "0"

Pull power plug out of socket

Shut off water supply

Actuate handgun to depressurise unit.

Detach water connection

Allow unit to cool down

Please consult your Kärcher dealer for details of regular safety inspection/maintenance agreement

Maintenance intervals**Once a week**

- Clean strainer in water connection
- Check oil level

Contact Kärcher AFTER-SALES SERVICE immediately if oil is opaque!

Once a month

- Clean strainer in low water protection
- Clean filter at cleaning-agent suction hose

After 500 hours of operation, at least once a year

- Change oil

MAINTENANCE TASKS**The indicator lamp (item.28) motor/electronics module is lit (only HDS 995 and HDS 1295)**

- * This warning lamp lights up when certain maintenance work is necessary due to accumulated operating hours.
- * When you open the cover (item 8) of the compartment (item 6) the electronic display is visible in the window (item 4).
- * Upon completing the necessary maintenance work the RESET button next to the display must be depressed at least 7 seconds until the warning lamp goes out.

Display**Necessary maintenance work**

- Visual inspection
- Check that the high-pressure connections do not leak
- Clean the fuel tank and the filter

Display**Necessary maintenance work**

- Check that the pump does not leak
- Change the pump's oil
- Clean strainer in water connection
- Clean the strainer (coarse) fitted in front of the low water protection

Display**Necessary maintenance work**

- Decarbonise the heating coil *
- Descale the heating coil *
- Clean/replace the ignition electrodes *
- Clean/replace the burner jet *
- Adjust the burner *

Display**Necessary maintenance work**

- Check the overflow valve for leaks *
- Check the high-pressure hose *
- Clean the handgun
- Check the pulsation damper *

* This maintenance work should be performed only by after-sales service.

Cleaning strainer in water connection (HDS 745, HDS 695 S, HDS 895 S, HDS 995, HDS 1195, HDS 1295, HDS Super)**Figure 10**

- Remove strainer
- Clean in water and re-insert

Cleaning strainer in low water protection (HDS 745, HDS 695 S, HDS 895 S, HDS 995, HDS 1195, HDS 1295, HDS Super)**Figure 11**

- Unfasten union nut and detach hose

Figure 12

- Take out strainer
- If necessary, screw in bolt M8 approx. 5mm to pull out strainer.
- Clean strainer in water
 - Slide in strainer
 - Mount hose
 - Tighten union nut

Cleaning filter at cleaning-agent suction hose

(HDS 745, HDS 695 S, HDS 895 S, HDS 995, HDS 1195, HDS 1295, HDS Super)

Figure 13

- Pull the cleaning agent suction inlet pipe out
- Clean filter in water and re-insert

Changing oil

(HDS 745, HDS 695 S, HDS 895 S, HDS 995, HDS 1195, HDS 1295, HDS Super)

Figure 14

- Provide a collecting container for approx. 1 litres of oil
- Loosen starting screw

* Dispose of used oil in appropriate manner or hand in at a collection point.

- Tighten drain plug again
 - Slowly fill with oil as far as MAX mark
- Air bubbles must be able to escape
Refer to technical data for oil grade and quantity to be used.

FAULTS

The indicator lamp- MOTOR/ELECTRONICS MODULE (item 28) flashes (only HDS 995 and HDS 1295)

- * This warning lamp flashes if there is a problem.
- * When you open the cover (item 8) of the compartment (item 6) the electronic display is visible in the window (item 4).
- * The warning lamp goes out when the problem has been resolved and the unit is switched on again.

Display

1				F
---	--	--	--	---

Troubleshooting

- Increase the water inlet volume
- Clean strainer in water connection
- Clean the strainer (coarse) fitted in front of the low water protection

Display

2				F
---	--	--	--	---

Troubleshooting

- Replace the reset switch for the low water protection *
- Clean the low water protection *

Display

3				F
---	--	--	--	---

Troubleshooting

- Eliminate the leakage in the high-pressure system

Display

7				F
---	--	--	--	---

Troubleshooting

- Motor is overloaded/overheated
- Set the monitoring switch to "0" and allow the motor to cool off for at least 5 min
- Have unit checked by After-Sales Service if this does not remedy fault

Display

6				F
---	--	--	--	---

Troubleshooting

This error code appears only on units equipped with the – accessory kit flame monitoring system -
See the assembly instructions – accessory kit flame monitoring system -

* This maintenance work should be performed only by after-sales service.

The READY FOR WORKING indicator lamp (item 28) goes out (HDS 745, HDS 695 S, HDS 895 S, HDS 1195, HDS Super)

Motor overloaded/overheated

- Set selector switch to "0" and allow motor to cool down for at least 5 min.
- Have unit checked by After-Sales Service if this does not remedy fault.
- No mains voltage (see – unit does not run -)

The FUEL indicator lamp (item 25) is lit (HDS 745, HDS 695 S, HDS 895 S, HDS 995, HDS 1195, HDS 1295, HDS Super)

Fuel tank empty

- Fill up

The READY FOR WORKING indicator lamp (item 29) goes out (HDS 745, HDS 695 S, HDS 895 S, HDS 995, HDS 1195, HDS 1295, HDS Super)

Engine is overloaded

- Set selector switch to "0" and allow motor to cool down for at least 5 min.
- Have unit checked by After-Sales Service if this does not remedy fault.
- No mains voltage (see – unit does not run -)

SCALE INHIBITOR indicator lamp (item 26) is lit (HDS 745, HDS 695 S, HDS 895 S, HDS 995, HDS 1195, HDS 1295, HDS Super)

Scale inhibitor reservoir empty; for technical reasons there is always a residual quantity in the reservoir.

- Fill up

Dirt on electrodes in reservoir

- Clean electrodes

Unit does not run**(HDS 745, HDS 695 S, HDS 895 S, HDS 995, HDS 1195, HDS 1295, HDS Super)**

No mains voltage

- Check mains connection/power cord

Unit does not build up pressure**(HDS 745, HDS 695 S, HDS 895 S, HDS 995, HDS 1195, HDS 1295, HDS Super)**

Air in system

- Bleed pump:
- * Set the cleaning agent metering valve (item 31) to "0"
- * While the handgun is open switch the unit on and off several times with the unit switch.
- * With handgun open, open and close regulator (Figure 9).
- * Venting is accelerated by removing the high-pressure hose from the high-pressure connection.
- Fill up cleaning-agent tank if empty.
- Check connections and lines

Pressure set to MIN

- Set pressure to MAX

Strainer in water connection dirty

- Clean strainer
- Insufficient water supply
- Check water supply volume (refer to technical data)
-

Unit leaking, water dripping out at bottom (HDS 745, HDS 695 S, HDS 895 S, HDS 995, HDS 1195, HDS 1295, HDS Super)

Pump leaking

- 3 droplets/min are permitted.
- In the event of a major leak, have unit checked by After-Sales Service.

Unit constantly switched on and off with handgun closed**(HDS 745, HDS 695 S, HDS 895 S, HDS 995, HDS 1195, HDS 1295, HDS Super)**

Leak in high-pressure system

- Check high-pressure system and connections for leaks

Unit does not draw in cleaning agent**(HDS 745, HDS 695 S, HDS 895 S, HDS 995, HDS 1195, HDS 1295, HDS Super)**

Operate the unit with an opened cleaning agent metering valve and a shut off water inlet until

the float tank is suctioned empty and the pressure drops to "0".

- Now reopen the water inlet.

If the pump still does not suction up cleaning agent the reasons can be as follows:

- Filter in cleaning-agent suction hose dirty
- Clean filter

Non-return valve gummed up

- Pull the cleaning agent hose off and detach the non-return valve with a blunt object, see Figure 15.

Burner not ignited**(HDS 745, HDS 695 S, HDS 895 S, HDS 995, HDS 1195, HDS 1295, HDS Super)**

Fuel tank empty

- Fill up

Lack of water

- Check water connection, check supply lines, clean low water protection.

Fuel filter dirty

- Replace fuel filter.

Incorrect direction of rotation. If direction of rotation is correct, powerful jet of air will be felt at exhaust-gas opening of burner.

- Check direction of rotation. If necessary change the poles at the unit plug. See figure 16.

No ignition spark

- Have unit checked by After-Sales Service if no ignition spark is visible through inspection glass during operation.

Set temperature not attained when working with hot water**(HDS 745, HDS 695 S, HDS 895 S, HDS 995, HDS 1195, HDS 1295, HDS Super)**

Excessive operating pressure/flow rate

- Reduce operating pressure/flow rate by way of regulator (Figure 9)

Soot deposits on heating coil

- Have After-Sales Service remove soot deposits from unit

If the problem cannot be resolved the unit must be checked by after sales service.

WARRANTY

The warranty terms and conditions issued by our responsible sales company apply in every country. Within the warranty period, any faults in the unit will be rectified free of charge provided that the problem was caused by a material defect or manufacturing error.

The warranty only applies if the dealer fills in, stamps and signs the enclosed reply card when the unit is sold and the purchaser then returns it to the appropriate local distributor.

In the event of a warranty claim, please contact your dealer or the nearest authorised After-Sales Service office and produce both accessories and proof of purchase.

GENERAL INSTRUCTIONS

Safety features

* Overflow valve with two pressure switches
When reducing water volume at pump head or with the servopress control, the overflow valve will open and part of the water will flow back to the pump suction side.

If the handgun is closed thus causing all the water to return to the pump suction end, the pressure switch at the overflow valve shuts off the pump.

Reopening the handgun causes the pressure switch at the cylinder head to switch the pump back on again.

The overflow valve is set at the factory and lead-sealed. Adjustment can only be made by After-Sales Service.

* Safety valve

The safety valve opens if the overflow valve or pressure switch is defective. The safety valve is set at the factory and sealed. Adjustment can only be made by After-Sales Service.

* Low water protection

The low water protection stops the burner being switched on in the event of a lack of water. A strainer stops the protection feature becoming dirty and requires regular cleaning.

* Motor protection switch

The motor protection switch interrupts the circuit should overloading occur.

Guidelines for liquid spraying equipment

* The accident prevention directive (BGV D 15) Work with Jets of Liquids is applicable. In accordance with these guidelines, high-pressure spraying equipment must be checked at least every 12 months by an expert and the results of the inspection recorded in writing.

Order governing boilers

* The testing pressure and the design of the unit comply with the steam boiler directive!. The water content of the heating coil is less than 10 litres. The boiler section of the unit is thus not subject to installation regulations. Local building regulations are to be heeded.

Switching on procedures

* Switching on procedures generate brief voltage drops. Impairments of other appliances can occur in cases of unfavourable mains conditions. No problems are to be expected with a mains impedance of less than 0,15 ohm.

TECHNICAL DATA

Type	HDS Super (1.025)	HDS 695 S * AUS (1.025-305)	HDS 745 (1.026)	HDS 895 S (1.027)
Mains connection	420 V 3~ 50 Hz 6,4 kW 16 A	420 V 3~ 50 Hz 5,6 kW 16 A	240 V 1~ 50 Hz 3,2 kW 16 A	420 V 3~ 50 Hz 6,8 kW 16 A
Water connection				
Supply temperature	max.30 °C	max.30 °C	max.30 °C	max.30 °C
Supply volume	min. 1200 l/h	min. 1000 l/h	min. 1000 l/h	min. 1200 l/h
Suction height when drawn from open tank (at 20°C water temperature)	0,5 m	0,5 m	0,5 m	0,5 m
Performance data				
Flow rate: cold/hot water	900-450 l/h	800-400 l/h	700-350 l/h	1000-470 l/h
Operating pressure: cold/hot water	180-30 bar	150-30 bar	110-30 bar	180-30 bar
(with standard nozzle supplied)				
Flow rate: steam	450 l/h	400 l/h	350 l/h	470 l/h
Operating pressure: steam (with steam nozzle (4-766-023))	max.32 bar	max.32 bar	max.32 bar	max.32 bar
Operating temperature				
- Hot water	max.90 °C	max.90 °C	max.90 °C	max.90 °C
- Steam	98-155 °C	98-155 °C	98-155 °C	98-155 °C
Cleaning-agent intake	0 - 35 l/h	0 - 35 l/h	0 - 35 l/h	0 - 40 l/h
Burner output	62 kW	62 kW	50 kW	68 kW
Recoil force of handgun	32 N	32 N	24 N	43 N
Sound level as per EN 60704-1	79 dB(A)	72 dB(A)	70 dB(A)	72 dB(A)
Vibration of the unit according to ISO 5349	2,6 m/s ²	1,9 m/s ²	2,2 m/s ²	1,9 m/s ²
Fuels				
Fuel	Fuel oil EL or diesel	Fuel oil EL or diesel	Fuel oil EL or diesel	Fuel oil EL or diesel
Oil quantity	0,6 l	0,75 l	0,75 l	0,75 l
Oil grade	Hypoid SAE90 (6.288-016)	Hypoid SAE90 (6.288-016)	Engine oil 15W40 (6.288-050,0)	Hypoid SAE90 (6.288-016)
Dimensions and weights				
Length x Width x Height	1285x690x835 mm	1285x690x835 mm	1285x690x835 mm	1285x690x835 mm
Weight not incl. accessories	133 kg	130 kg	130 kg	133 kg
Fuel tank	25 l	25 l	25 l	25 l
Cleaning-agent tank	20 l	20 l	20 l	20 l



Type	HDS 995 (1.027)	HDS 1195 (1.028)	HDS 1295 (1.028)
Mains connection	420 V 3~ 50 Hz 6,8 kW 16 A	420 V 3~ 50 Hz 8,2 kW 16 A	420 V 3~ 50 Hz 8,2 kW 16 A
Water connection	max.30 °C min. 1200 l/h 0,5 m	max.30 °C min. 1500 l/h 0,5 m	max.30 °C min. 1500 l/h 0,5 m
Performance data	1000-470 l/h 180-30 bar 470 l/h max.32 bar max.90 °C 98-155 °C 0 - 40 l/h 68 kW 43 N 72 dB(A) 1,9 m/s ²	1200-600 l/h 180-30 bar 600 l/h max.32 bar max.90 °C 98-155 °C 0 - 48 l/h 92 kW 60 N 76 dB(A) 2 m/s ²	1200-600 l/h 180-30 bar 600 l/h max.32 bar max.90 °C 98-155 °C 0 - 48 l/h 92 kW 60 N 76 dB(A) 2 m/s ²
Fuels	Fuel oil EL or diesel 0,75 l Hypoid SAE90 (6.288-016)	Fuel oil EL or diesel 0,75 l Hypoid SAE90 (6.288-016)	Fuel oil EL or diesel 0,75 l Hypoid SAE90 (6.288-016)
Dimensions and weights	1285x690x835 mm 133 kg 25 l 20 l	1285x690x875 mm 155 kg 25 l 20 l + 17 l	1285x690x875 mm 155 kg 25 l 20 l + 17 l





HDS 655
 HDS 695 S
 HDS 895 S
 HDS 995
 HDS 1195
 HDS 1295
 HDS SUPER

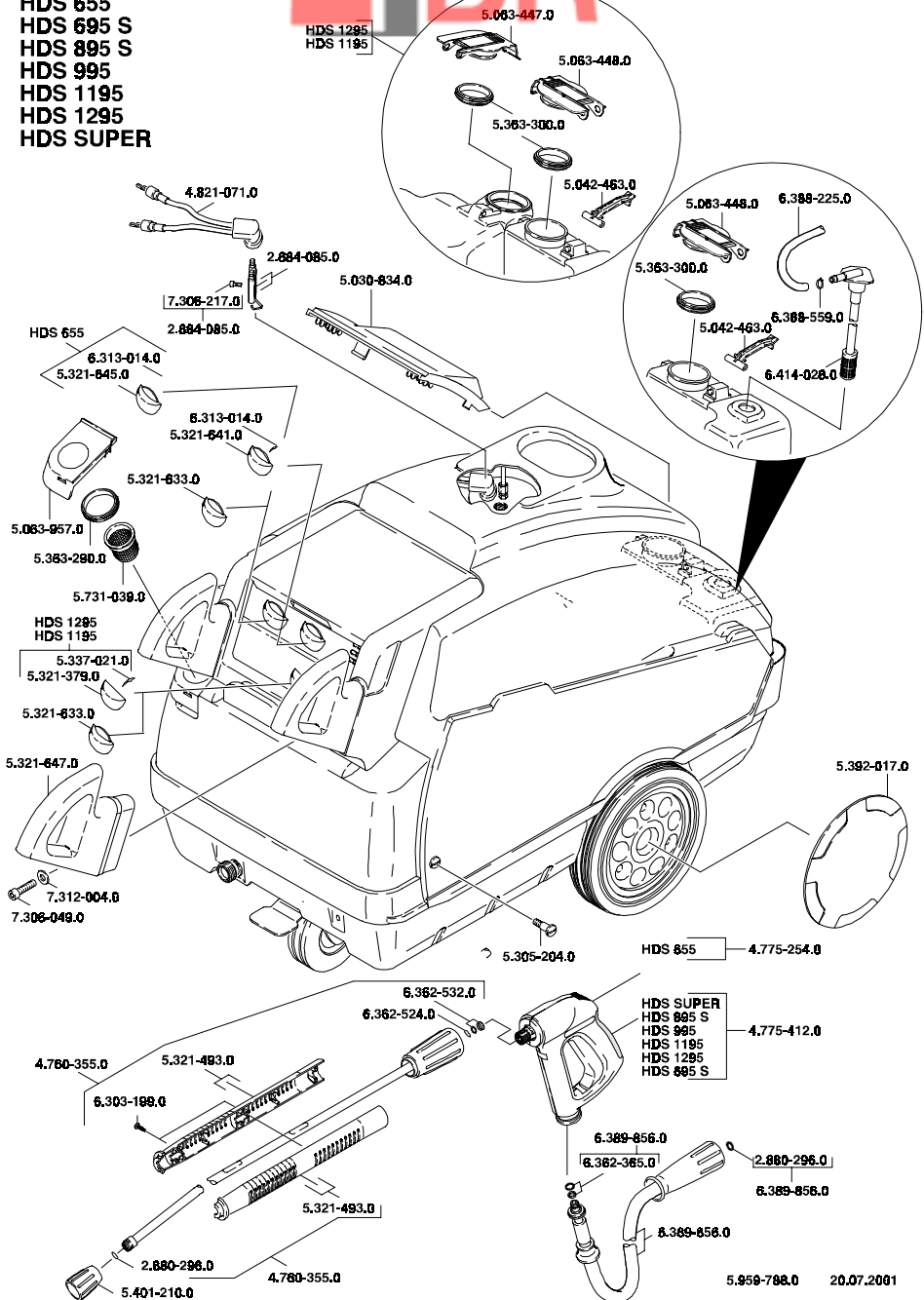



EU DECLARATION OF CONFORMITY

We hereby declare that the equipment described below conforms to the relevant fundamental safety and health requirements of the appropriate EU Directives, both in its basic design and construction as well as in the version marketed by us. This declaration will cease to be valid if any modifications are made to the machine without our express approval.

Product: High-pressure cleaner with steam stage

Model: 1.025-xxx, 1.026-xxx, 1.027-xxx, 1.028-xxx

Relevant EU Directives:

EU Machinery Directive (98/37/EG); EU Low-Voltage Equipment Directive (73/23/EWG) amended by 93/68/EWG; EU Directive on Electromagnetic Compatibility (89/336/EWG) amended by 91/263/EWG, 92/31/EWG, 93/68/EWG
EU - pressure-operated units regulations (97/23/EG)

Harmonised standards applied:

DIN EN 60 335-1, DIN EN 60 335-2-79,
DIN EN 55 014-1:1999, DIN EN 55 014-2:1997,
DIN EN 61 000-3-2:1995, DIN EN 61 000-3-3:1995

Relevant EU Directives:

TRD 801, TRD 301, DIN 2413

Appropriate internal measures have been taken to ensure that series-production units conform at all times to the requirements of current EU Directives and relevant standards. The signatories are empowered to represent and act on behalf of the company management.



5.957-649 (07/01)

Alfred Kärcher Limited Partnership.
Registered office: Winnenden. Company Register:
Waiblingen, HRA 169.
Personally liable partner. Kärcher Reinigungstechnik GmbH.
Registered office Winnenden, 2404 Waiblingen Company
Register, HRB

Managing directors:
Dr. Bernhard Graf, Hartmut Jenner, Roland Kamm,
Herbert Konhäusner, Georg Metz, Thomas Schöbinger

Alfred Kärcher GmbH & Co.
Cleaning Systems
Alfred-Kärcher-Straße 28-40
P.O.Box 160
D-71349 Winnenden, Germany
Phone: ++49 7195 14-0
Fax :++49 7195 14-2212

(Graf

Reiser

Schöbinger)